



EPA Certified / Stationary Emergency

OUTPUT POWER OPTIONS					Natural Gas STANDBY RATING		LP Vapor STANDBY RATING		sKVA
Make	Voltage	Alternator	Phase	Hertz	kW/kVA	Amps	kW/kVA	Amps	30% Voltage Dip
Stamford	600	HCI534E17	3	60	450/563	542	303/379	365	1670
	277/480	HCI534E311	3	60	450/563	677	303/379	456	1750
	120/208	HCI534E311	3	60	450/563	1563	303/379	1053	1390
	120/240	HCI534E311	3	60	450/563	1355	303/379	912	1390
	120/240	HCI534E311	1	60	273/273	1138	273/273	1138	930
Marathon	600	572RSS4270	3	60	450/563	542	303/379	365	1040
	277/480	572RSL4027	3	60	450/563	677	303/379	456	1890
	120/208	572RSL4027	3	60	450/563	1563	303/379	1053	1400
	120/240	572RSL4027	3	60	450/563	1355	303/379	912	1400
	120/240	572RSL4027	1	60	283/283	1179	283/283	1179	470
Marathon	277/480	572RSL4029	3	60	450/563	677	303/379	456	2180
	120/208	572RSL4029	3	60	450/563	1563	303/379	1053	1625
	120/240	572RSL4029	3	60	450/563	1355	303/379	912	1625
	120/240	572RSL4029	1	60	308/308	1283	285/285	1188	480



Engine Data

Manufacturer	PSI	
Model	21.9L	
Aspiration	Turbocharged	
Arrangement	V-12, 4-Cycle	
Firing Order	1-12-5-8-3-10-6-7-2-11-4-9	
Displacement: L (in. ³)	21.9 (1338.0)	
Bore: mm (in.)	128.00 (5.04)	
Stroke: mm (in.)	142.00 (5.59)	
Compression Ratio	10.5:1	
Gross Horsepower: Natural Gas	684	
LP Vapor	472	
BMEP: psi (kPa)	Natural Gas	225.00 (1551.32)
	LP Vapor	155.00 (1068.70)
Rated RPM	1800	
Governor	Isochronous	
Speed Regulation	±0.50%	

Engine Liquid Capacity

Oil System: qt. (L)	38.5 (36.5)
Cooling Capacity: gal (L)	50.1 (189.6)

Engine Electrical

Electric Volts: DC	24
Cold Cranking Amps	1100
Battery(s) Required	2

Fuel System

Fuel Supply Size:	Natural Gas	3.00" NPT
	LP Vapor	3.00" NPT
Supply Pressure: in. H ₂ O (kPa)	7-11 (1.74-2.74)	

Air Requirements

Air Filter(s) Type	Dry
Combustion Air Flow: CFM (m ³ /min)	968 (27)
Maximum Air Intake Restriction	
Clean: in. H ₂ O (kPa)	3.00 (1.24)
Dirty: in. H ₂ O (kPa)	15.00 (3.74)
Radiator Air Flow: CFM (m ³ /min)	40,000 (1133)

Exhaust System

Gas Temperature: °F (°C)	1382 (750)
Gas Flow: CFM (m ³ /min)	2995.0 (84.8)
Max Back Pressure: in. H ₂ O (kPa)	40.9 (10.2)

Filters and Quantity

Air Cleaner Quantity	1
Oil Filter(s) Quantity	1

Fuel Consumption - Natural Gas

At 100% of Power Rating: CFH (m ³ /hr)	4490.0 (127.1)
At 75% of Power Rating: CFH (m ³ /hr)	N/A
At 50% of Power Rating: CFH (m ³ /hr)	N/A
At 25% of Power Rating: CFH (m ³ /hr)	N/A

Fuel Consumption - LP Vapor

At 100% of Power Rating: CFH (m ³ /hr)	1408.0 (39.9)
At 75% of Power Rating: CFH (m ³ /hr)	N/A
At 50% of Power Rating: CFH (m ³ /hr)	N/A
At 25% of Power Rating: CFH (m ³ /hr)	N/A

GENERAL GUIDELINES FOR DERATION: Altitude: Derate 0.5% per 100m (328 ft.) Elevation above 1000m (3279 ft.) Temperature: Derate 1.0% per 10°C (18°F) temperature above 25°C (77°F)

RATINGS: All three-phase units are rated at 0.8 power factor. All single-phase units are rated at 1.0 power factor.

125° RATINGS: 125° apply to installations served by a reliable utility source. The standby rating is applicable to varying loads for the duration of a power outage. There is no overload capability for this rating. Ratings are in accordance with ISO-3046/1, BS 5514, AS 2789, and DIN 6271. For limited running time and base load ratings consult the factory. The generator set manufacturer reserves the right to change the design or specifications without notice and without any obligation or liability whatsoever.

Alternator Data

Manufacturer	Stamford	
Type	PMG	
Insulation Class	NEMA H	
Temperature Rise	125°C Standby	
Hertz	60	
RPM	1800	
Amortisseur Windings	Full	
CFM Cooling Required	2780	
Voltage Regulator	MX341	MX321
Sensing	Single Phase	Three Phase
Voltage Regulation	1.0%	0.50%

Features

- BS EN 60034, BS5000, VDE 0530, NEMA MG1-32, IEC34, CSA C22.2-100, and AS1359 compliant
- IP23 enclosure
- Dynamically balanced to exceed BS6861:Part 1 Grade 2.5 vibration standard
- Quality assurance to BS EN ISO 9001
- Self-ventilated and Drip proof construction
- Two-thirds pitch stator and skewed rotor
- Heavy duty bearings
- Fully guarded
- Overexcitation protection
- Under frequency protection
- Analog input
- Overvoltage protection
- Paralleling compatible

Alternator Data

Manufacturer	Marathon	
Type	PMG	
Insulation Class	NEMA N	
Temperature Rise	125°C Standby	
Hertz	60	
RPM	1800	
Amortisseur Windings	Full	
CFM Cooling Required	1520	
Voltage Regulator	DVR2400	PM500
Sensing	Three Phase	Three Phase
Voltage Regulation	0.25%	0.25%

Features

- NEMA MG1-32, BS5000, and IEC 34-1 compliant; CE & CSA Certified and UL Listed
- Self-ventilated and drip proof construction
- Two-thirds pitch stator and skewed rotor
- Wet wound, epoxied field windings
- Designed to withstand overspeeds of up to 125%
- Hybrid analog/digital voltage regulator
- Under frequency protection
- Under frequency indication light
- Less than one cycle response time
- Over excitation protection
- Over excitation indication light
- Easy access front-panel adjustments
- Over voltage protection shutdown

Control Panels



DeepSea 7310 MKII

Simultaneous Use of RS232 & RS485
 Modbus RTU Support
 Fully Configurable Using USB, RS232 & RS485
 IP65 Rating
 6 Programmable Inputs & 8 Outputs
 UL & cUL Listed and CE Certified



Basler DGC2020

SAE J1939 Engine ECU Communications
 4 Programmable Inputs & 10 Outputs
 Modbus Communications With RS485
 UL Recognized, CSA & CE Certified
 IP 54 Front Panel Rating
 NFPA 110 Level 1 Compatible
 Manual Override Keyswitch
 DGC2020HD Variant Available



Taylor Analog

Automatic CANBUS Engine Control
 Gauge Zeroing on Shutdown
 Auto-Off-Manual Control Switch
 Oil Pressure, Water Temperature, Battery Voltage and RPM Gauges
 AC Voltage, Frequency, Percent of Load, and Run-Time Metering
 LED Status Lights

Standard Features:

Warranty

2 Year Standard
5 Year Comprehensive

- | | |
|------------------------------------|------------------------|
| Heavy Duty Steel Base | Battery Charger |
| Vibration Isolators | Block Heater |
| Oil Drain Valve with Extension | Factory Powder Coating |
| Coolant Drain Kit | Factory Load Test |
| High Ambient Unit Mounted Radiator | Owner's Manual |

Controller Options

DGC2020HD Controller
Fiber Optic Ethernet (DGC2020HD)
RS-232 Port & Generator Protection (DGC2020)
Flush or Surface Mount Remote Annunciator
Remote Mount Break Glass E-Stop Switch

Miscellaneous Options:

- | | |
|------------------------|-------------------------|
| Generator Strip Heater | Pad Type Battery Heater |
| Spring Isolators | Battery Heater Blanket |
| Line Circuit Breaker | Oil Pan Heater |

Open Unit

Options:

- Radiator Duct Flange
- Flex Exhaust
- Critical Silencer

Overall Size: 140"L x 90"W x 98"H
Approximate Weight: 11,350 lbs.

Note: Dimensions and weights reflect standard open unit with no options and are subject to change.

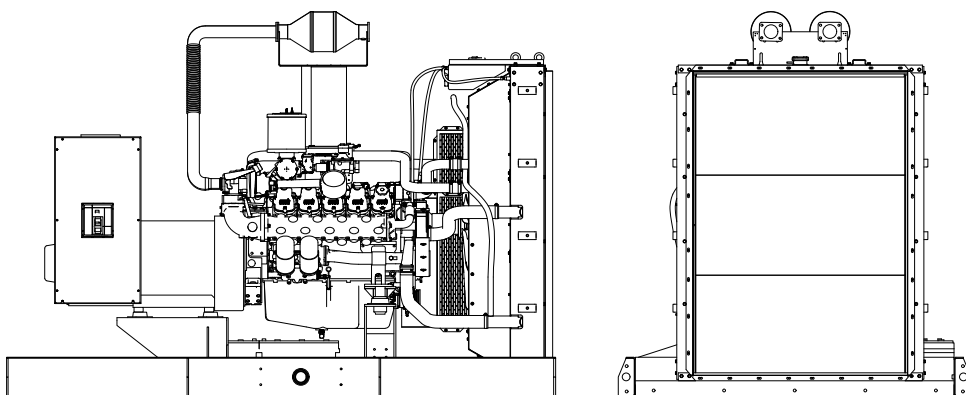

Standard Enclosed Unit

Options:

- Sound Attenuated Enclosure
- Load Center, Lights & GFI Receptacle

Overall Size: 186"L x 90"W x 106"H
Approximate Weight: 13,650 lbs.

Note: Dimensions and weights reflect standard enclosed unit with no options and are subject to change.

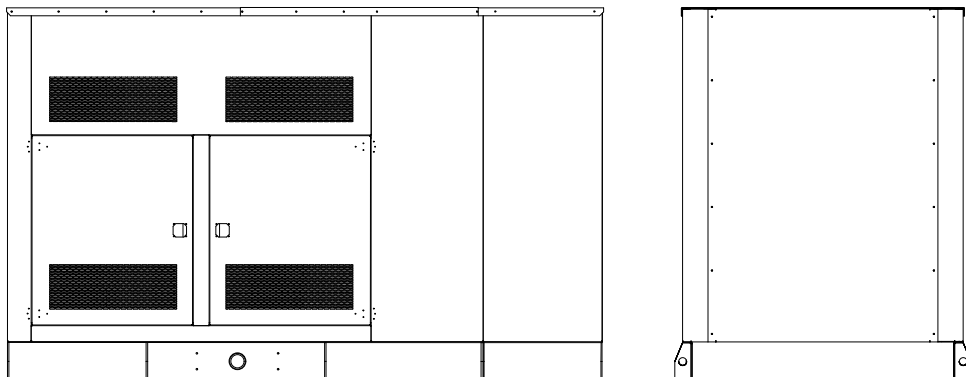

Note: The above drawings are provided for reference only and should not be used for planning installation. Contact your local distributor for more information.